

Varenummer: 0101216
 Beskrivelse: Seeger låsering A 390 DIN 471
 Fjederstål
 Note: Monteres med ZGA tang

Mål

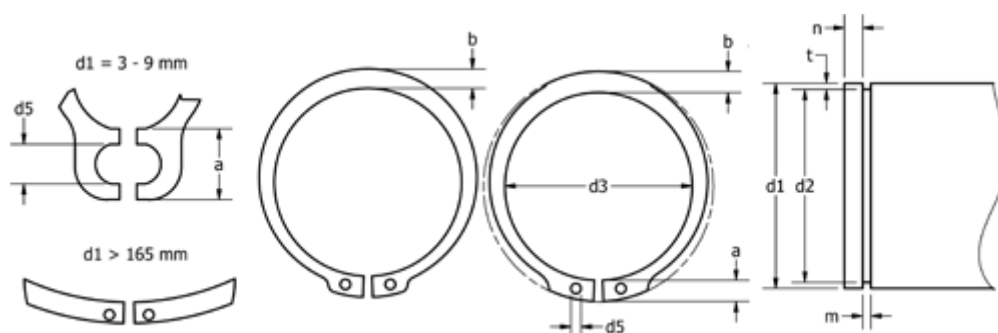

a max	= -	FN kN	= 1008.0	s	= 6.00
AN mm ²	= 6050.0	FRg kN	= 70.00	t	= 5.00
b	= 20.0	FR kN	= 814.00	Tang	= ZGA-6
Betegnelse	= A390	g	= 7.0	tol	= -0.15
d1	= 390	K kN-mm	= 1865.00	tol	= +0,90-2,00
d2	= 380.0	m min	= 6.20	tol	= -0.89
d3	= 373.0	n abl x 1000	= 1.0	vægt kg/1000	= 950.000
d5 min	= 6.0	Nominel træk	= 15.0		